

EMBASE CRUCIFORME À VISSER 8099

HETTICH

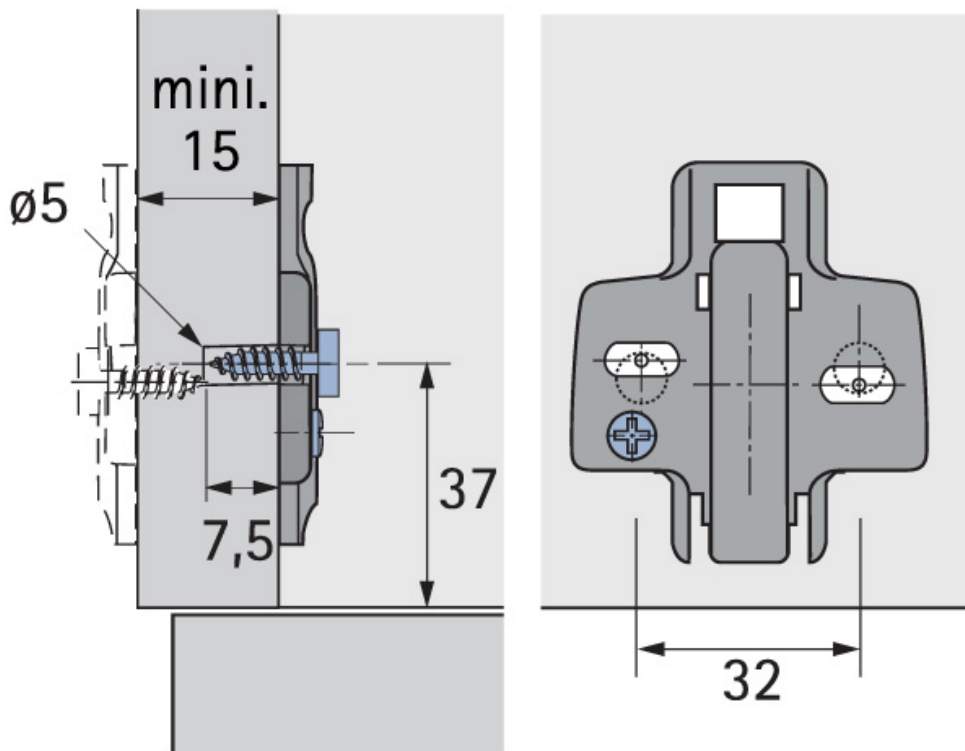

<https://www.qama.fr/embase-cruciforme-a-visser-p23385>



Tel : 02 43 13 49 49

Fax : 02 43 30 26 16

www.qama.fr