

FIXATIONS POUR ROULETTES Ø 50/65/75 MM

GUY RAYMOND

GUY-RAYMOND
ENGINEERING COMPANY LIMITED

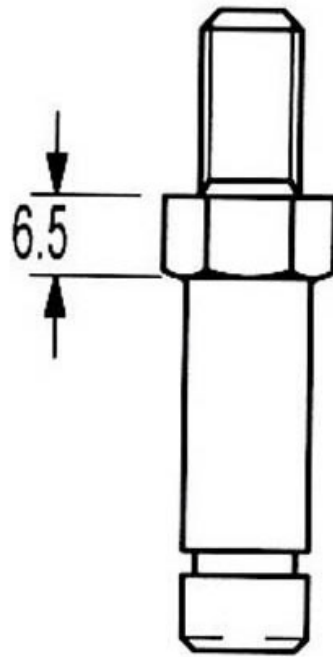

M8 x 15

<https://www.qama.fr/fixations-pour-roulettes-diam50-65-75-p8467>



Tel : 02 43 13 49 49

Fax : 02 43 30 26 16

www.qama.fr

FIXATIONS POUR ROULETTES Ø 50/65/75 MM

GUY RAYMOND

GUY-RAYMOND
ENGINEERING COMPANY LIMITED

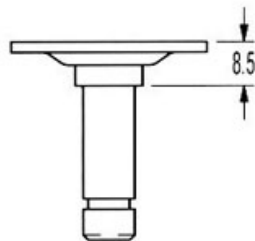
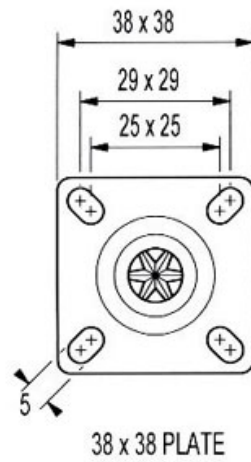

<https://www.qama.fr/fixations-pour-roulettes-diam50-65-75-p8467>



Tel : 02 43 13 49 49

Fax : 02 43 30 26 16

www.qama.fr

FIXATIONS POUR ROULETTES Ø 50/65/75 MM

GUY RAYMOND

GUY-RAYMOND
ENGINEERING COMPANY LIMITED

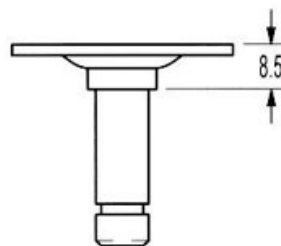
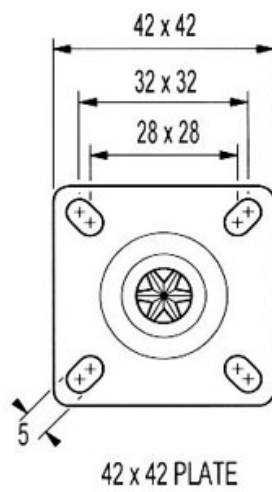

<https://www.qama.fr/fixations-pour-roulettes-diam50-65-75-p8467>



Tel : 02 43 13 49 49

Fax : 02 43 30 26 16

www.qama.fr

FIXATIONS POUR ROULETTES Ø 50/65/75 MM

GUY RAYMOND

GUY-RAYMOND
ENGINEERING COMPANY LIMITED

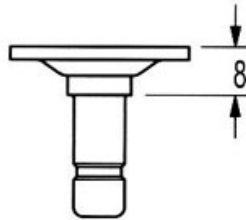
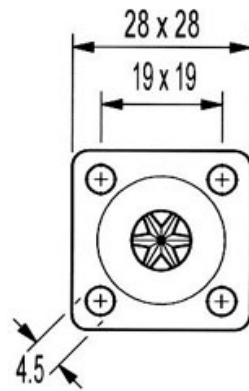

<https://www.qama.fr/fixations-pour-roulettes-diam50-65-75-p8467>



Tel : 02 43 13 49 49

Fax : 02 43 30 26 16

www.qama.fr