

GOUJONS À VISSER DU 426

HETTICH

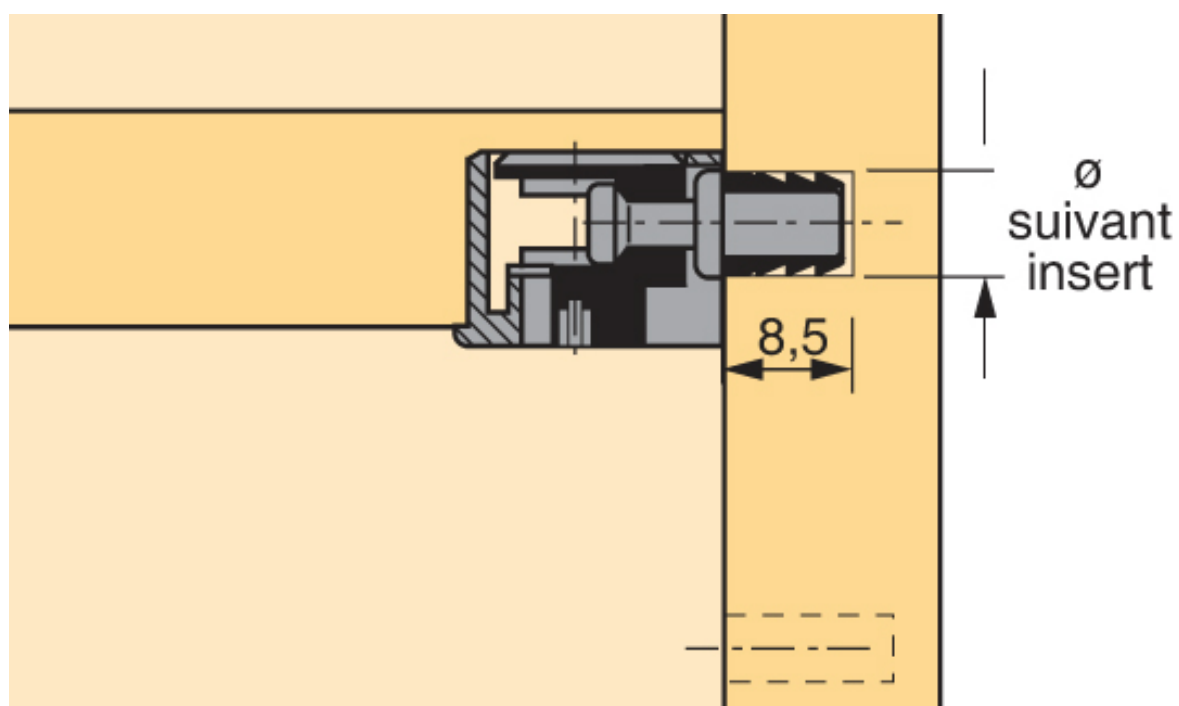

<https://www.qama.fr/goujons-a-visser-du-426-p21687>



Tel : 02 43 13 49 49

Fax : 02 43 30 26 16

www.qama.fr

GOUJONS À VISSER DU 426

HETTICH

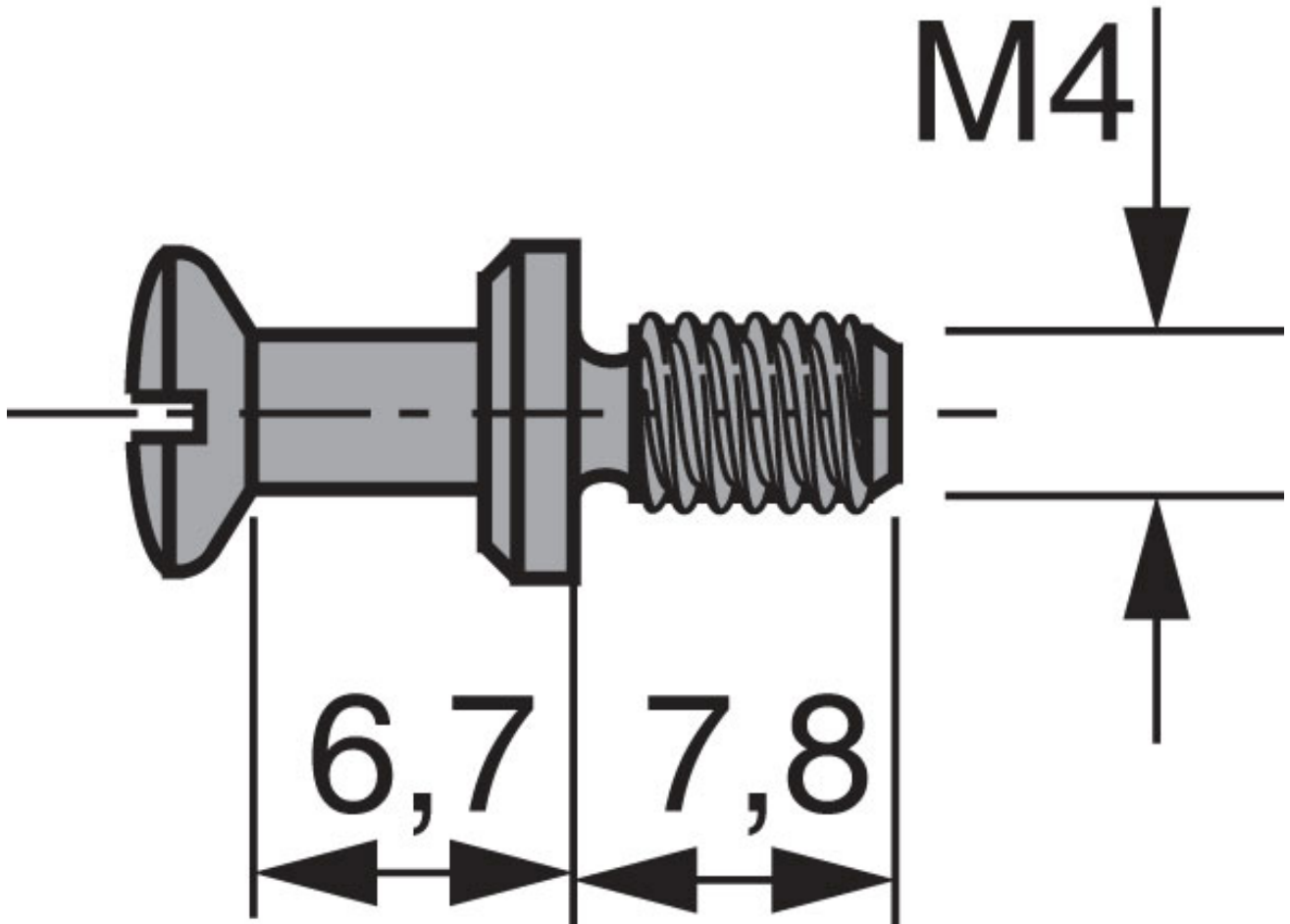

<https://www.qama.fr/goujons-a-visser-du-426-p21687>



Tel : 02 43 13 49 49

Fax : 02 43 30 26 16

www.qama.fr