

PIED ACIER Ø 28MM AVEC EMBASE

CAMAR

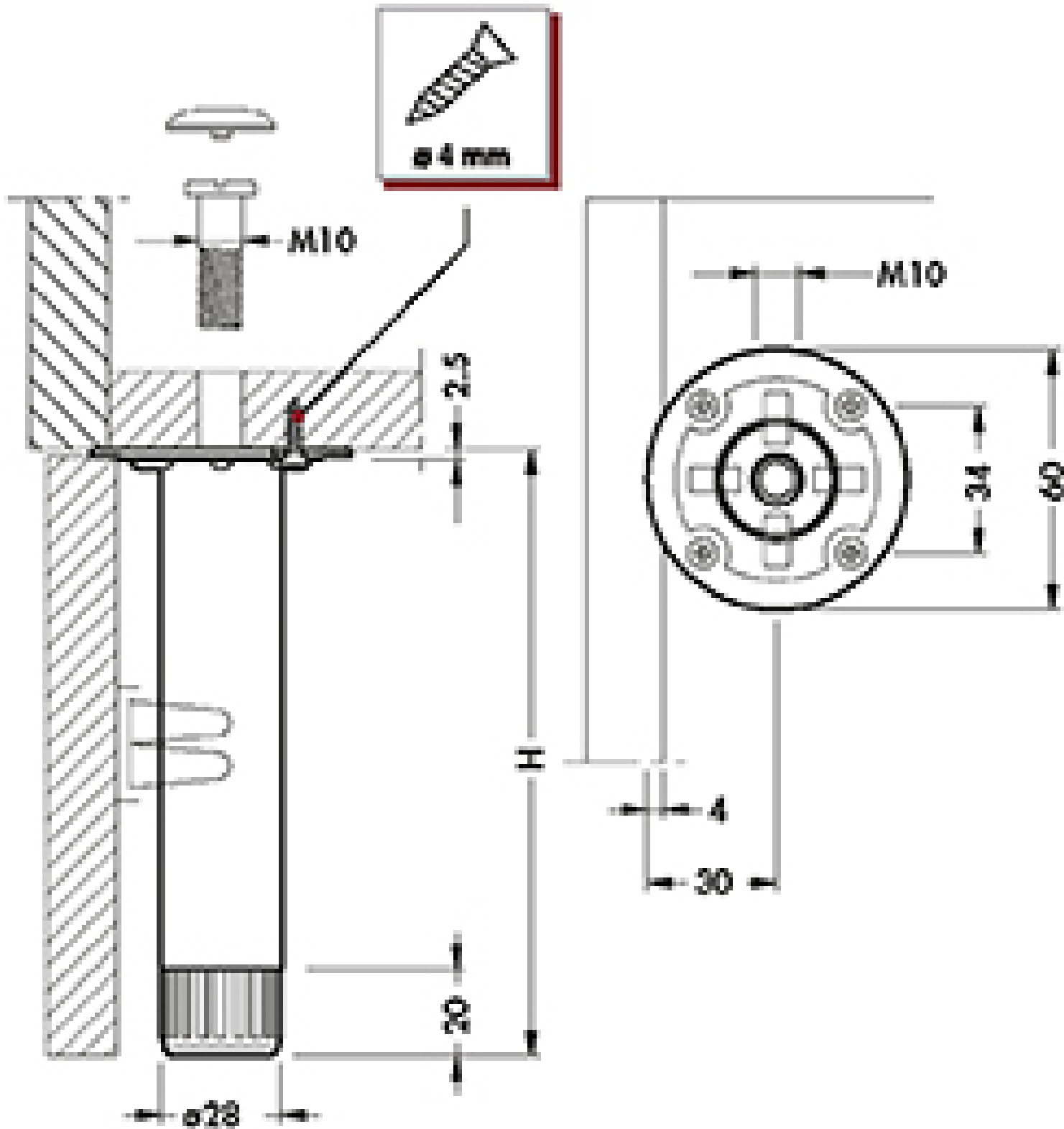

<https://www.qama.fr/pied-acier-diam28-avec-embase-p7345>



Tel : 02 43 13 49 49

Fax : 02 43 30 26 16

www.qama.fr